

**ARMANI DOMENICO SNC**  
 di **ARMANI GRAZIANO & C.**  
 produzione e vendita manufatti in cemento  
 V. A. Monga, 35/a  
 37029 SAN PIETRO IN CARIANO (VR)  
 TEL. 045 7701828  
 e.mail: armanimanufatti@virgilio.it  
 R.e.a./Cod.Fisc./Partita Iva 00815600234

PORTA CONTATORI energia elettrica

PORTACONTATORI EN .ELETTRICA TIPO INDUSTRIALE

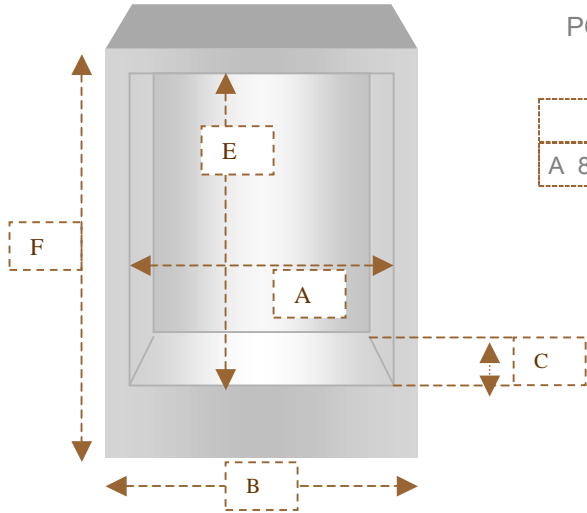

					Peso in kg
A 83 cm	B 95 cm	C 36 cm	E 140 cm	F 167 cm	600

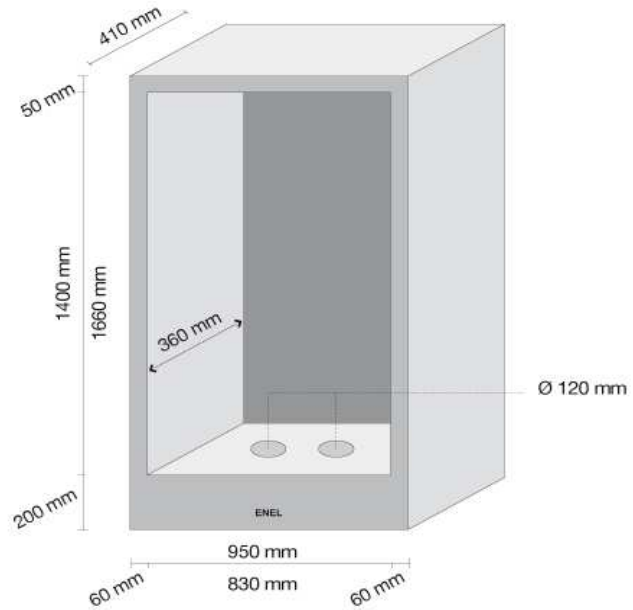

I disegni rappresentano i manufatti - non sono in scala

**ARMANI DOMENICO SNC**  
 di ARMANI GRAZIANO & C.  
 produzione e vendita manufatti in cemento  
 V. A. Monga, 35/a  
 37029 SAN PIETRO IN CARIANO (VR)  
 TEL. 045 7701828  
 e.mail: armanimanufatti@virgilio.it  
 R.e.a./Cod.Fisc./Partita Iva 00815600234

PORTA CONTATORI EN. ELETTRICA. CON COLONNA

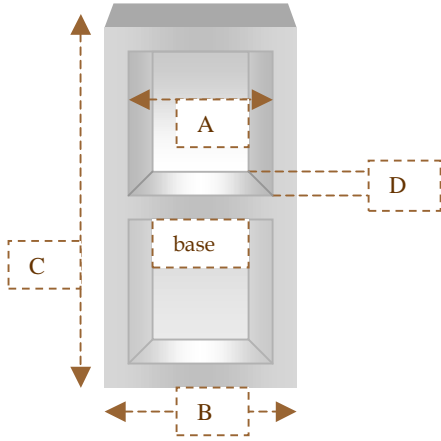

					Peso in kg
singolo monofase	A 26 cm	B 36 cm	C 112 cm	D 22 cm	153,5
doppio e/o trifase	A 42 cm	B 52 cm	C 112 cm	D 24 cm	210

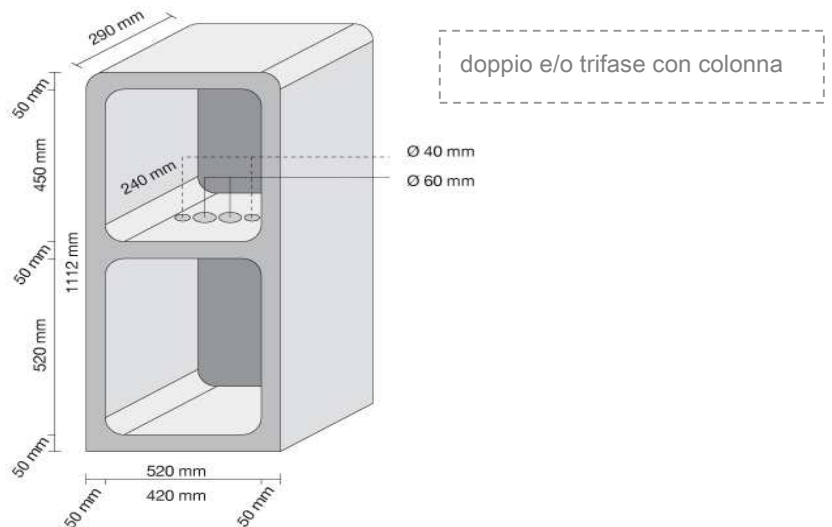
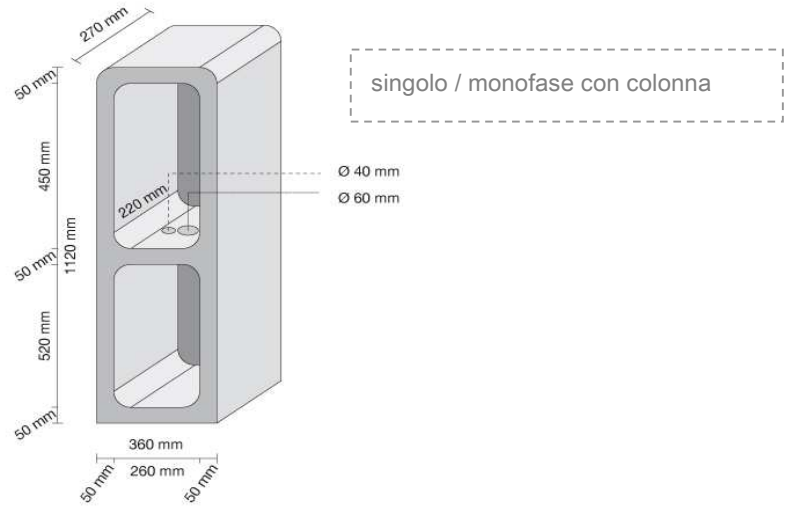

I disegni rappresentano i manufatti - non sono in scala

PORTA CONTATORI EN. ELETTRICA SENZA COLONNA

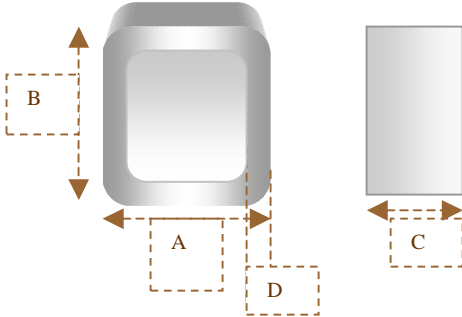

	A	B	C	D	Peso in kg
singolo monofase	35 cm	45 cm	25 cm	5 cm	68,8
doppio e/o trifase	52 cm	55 cm	29 cm	5 cm	93,5



singolo / monofase senza colonna

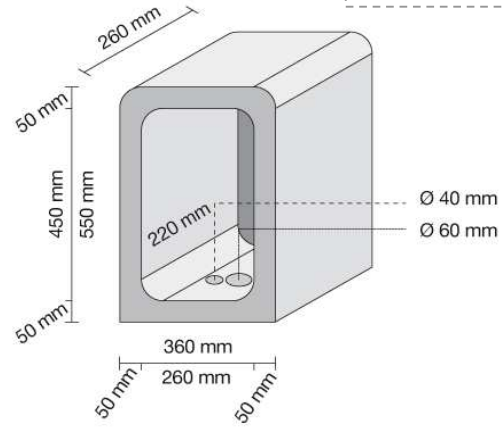

doppio e/o trifase senza colonna

